

CARDIOVASCULAR INSTRUMENTS

SURGIFACT[®]
EXCELLENCE IS OUR SPECIALTY



Cardiovascular Instruments
Rib Shears, Sternum Scissors and Sternum Chisels



Sauerbruch
 SF-07-70001 24 cm/9½"
 SF-07-70002 26 cm/10¼"



Giertz-Stille
 SF-07-70003
 27 cm/10½"



Sauerbruch-Frey
 SF-07-70004
 36 cm/14"



Bethune
 SF-07-70007
 34 cm/13½"

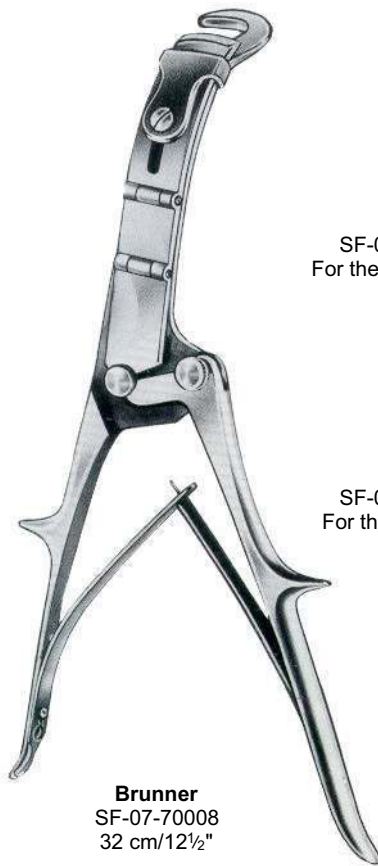

Brunner
 SF-07-70008
 32 cm/12½"

SF-07-70005
 For the Right Hand

SF-07-70006
 For the left Hand



Lebsche
 SF-07-70009
 24.5 cm/9¾"



Finocchietto-Baby

	a	b	c
SF-07-70010	18 mm	21 mm	105 mm

Scheme of Dimensions

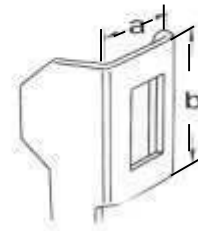

Size of Blades



Total Spread



Finocchietto

	a	b	c
SF-07-70011	36 mm	45 mm	165 mm
SF-07-70012	44 mm	65 mm	200 mm
SF-07-70013	44 mm	65 mm	250 mm
SF-07-70014	44 mm	65 mm	300 mm
SF-07-70015	65 mm	65 mm	200 mm
SF-07-70016	65 mm	65 mm	250 mm
SF-07-70017	65 mm	65 mm	300 mm

With 2 Pairs of Interchangeable Blades

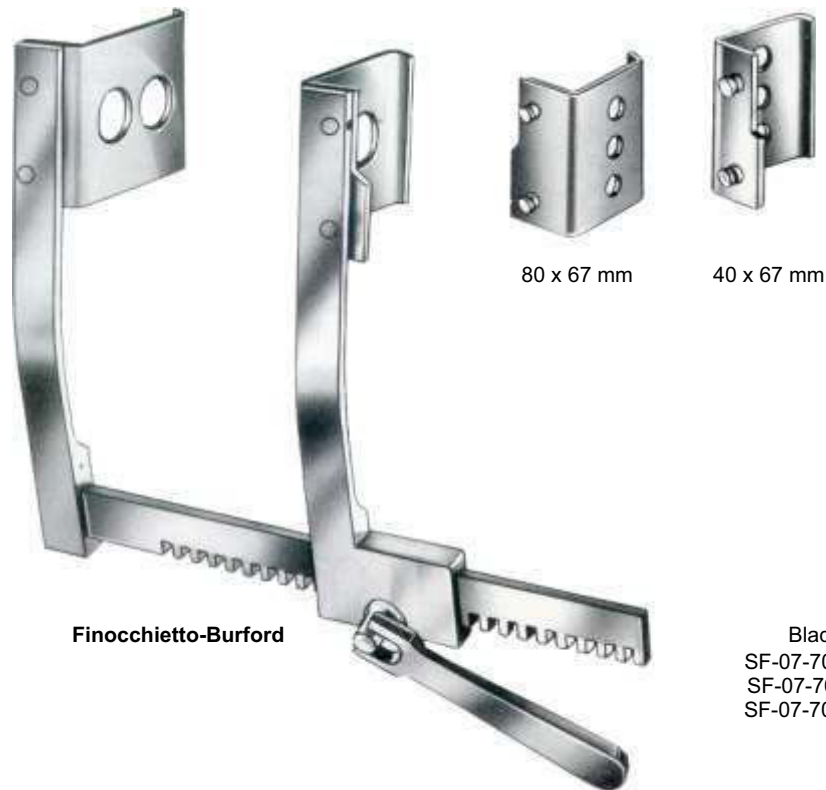

Finocchio-Burford

Blade Opening
SF-07-70018 200 mm/8"
SF-07-70019 250 mm/10"
SF-07-70020 305 mm/12"



Tuffier



Haight

	a	b	c
SF-07-70022	30 mm	30 mm	115 mm



**Cooley
(Cooley-Baby)**

	a	b	c
SF-07-70023	15 mm	30 mm	75 mm
SF-07-70024	21 mm	45 mm	145 mm
SF-07-70025	32 mm	50 mm	190 mm



De Bakey
 SF-07-70026
 With 3 Pairs of Blades
 SF-07-70027
 SF-07-70028
 SF-07-70029

Spreader only



SF-07-70030
 60 x 60 mm



SF-07-70031
 50 x 80 mm

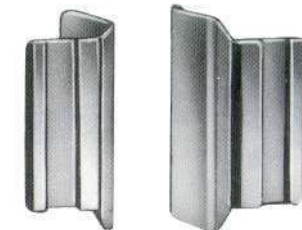

SF-07-70032
 40 x 100 mm

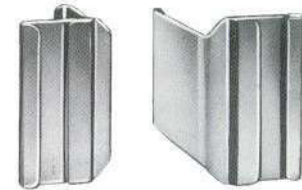

SF-07-70033
 80 x 60 mm



SF-07-70034
 50 x 66 mm

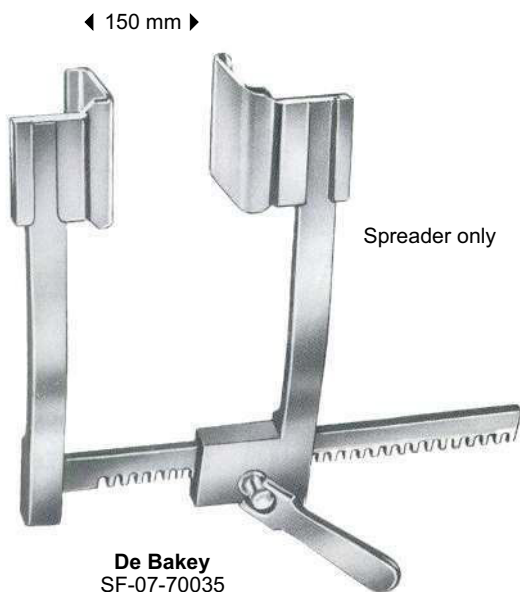

De Bakey
 SF-07-70035
 With 3 Pairs of Blades

Spreader only



SF-07-70036
 30 x 30 mm



SF-07-70037
 40 x 40 mm

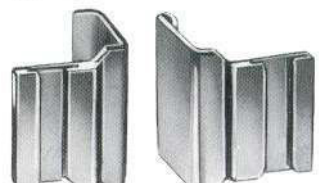

SF-07-70038
 50 x 50 mm

◀ Fig. 1 15 cm/6" ▶
◀ Fig. 2 20 cm/8" ▶



Morse-Favaloro
Fig. 1 SF-07-70039
Fig. 2 SF-07-70040

75 x 75 mm

42 x 65 mm

Thoracic Retractor



(Mercedes-Retractor)
SF-07-70041
Complete



**Cooley
(Cooley-Baby)**

	a	b	c
SF-07-70042	12 mm	17 mm	75 mm
SF-07-70043	16 mm	30 mm	105 mm
SF-07-70044	37 mm	49 mm	200 mm



Castaneda

	a	b	c
SF-07-70045	10.5 mm	32 mm	65 mm
SF-07-70046	12 mm	45 mm	70 mm
SF-07-70047	15 mm	60 mm	120 mm



Finocchietto-Baby-Haight

	a	b	c
SF-07-70048	15 mm	15 mm	75 mm
SF-07-70049	31 mm	31 mm	100 mm
SF-07-70050			



Finocchetto

	a	b	c
SF-07-70051	38 mm	44 mm	135 mm
SF-07-70052	52 mm	62 mm	135 mm
SF-07-70053	85 mm	65 mm	135 mm



Burford
With 2 Pairs of Blades

For Child	a	b	c
	48 mm	42 mm	135 mm
SF-07-70054	34 mm	42 mm	135 mm
SF-07-70055	65 mm	62 mm	180 mm
	47 mm	62 mm	
SF-07-70056	65 mm	62 mm	260 mm
	47 mm	62 mm	
SF-07-70057	65 mm	62 mm	300 mm
	47 mm	62 mm	



Lemmon
 SF-07-70058
 18 cm/7"



Sellors
 SF-07-70059
 19 cm/7½"



Bailey-Baby
 SF-07-70059
 14 cm/5½"



Bailey
 SF-07-70060
 16 cm/6¼"



Bailey-Gibbon
 SF-07-70061
 16 cm/6¼"



Allison
 SF-07-70062 25.5 cm/10"
 SF-07-70063 30.0 cm/12"

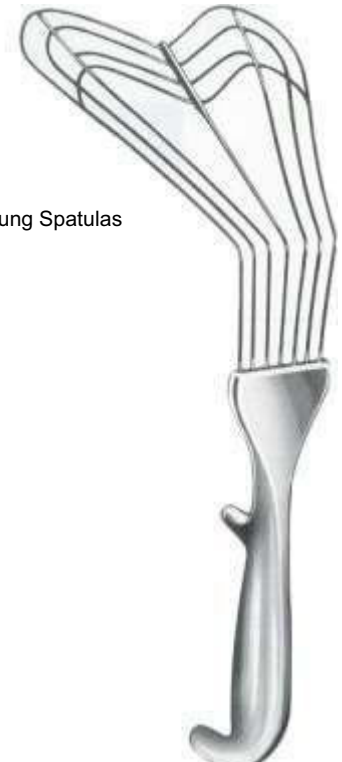

Lung Spatulas

SF-07-70064
 30 cm/12"



Price-Thomas
 SF-07-70065
 22 cm/8¾"

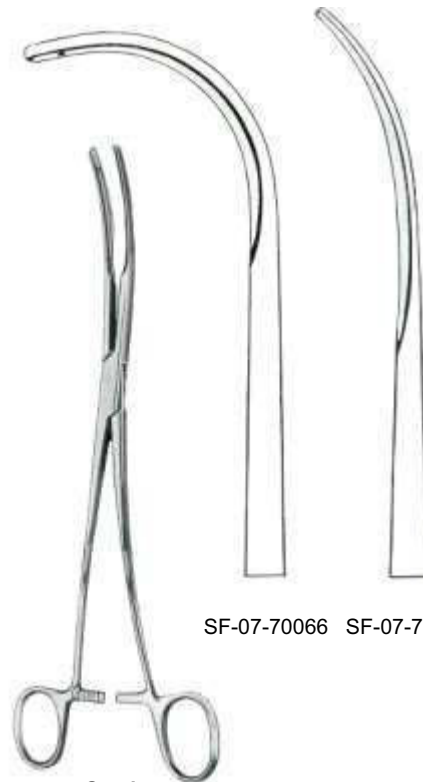

SF-07-70066 SF-07-70067

Semb
 24 cm/9½"

Lung grasping forceps

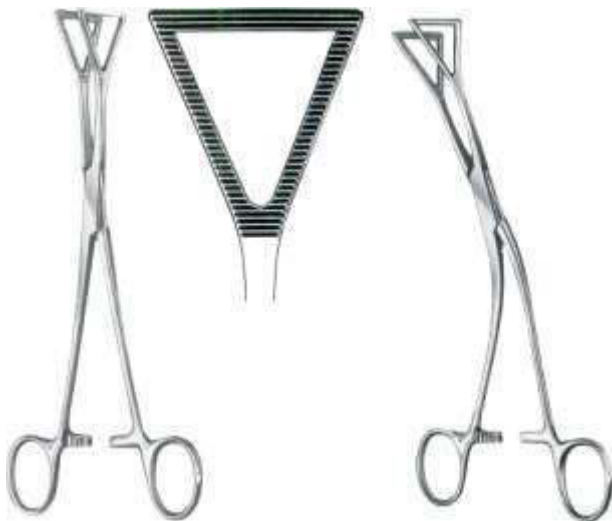

Lovelace
 SF-07-70068
 20 cm/8"

Lovelace
 SF-07-70069
 20 cm/8"



Fig. 2

Fig. 1

Satinsky
 26.5 cm/10½"
 Fig. 1
 Fig. 2

SF-07-70070
 SF-07-70071

SF-07-70072
 SF-07-70073

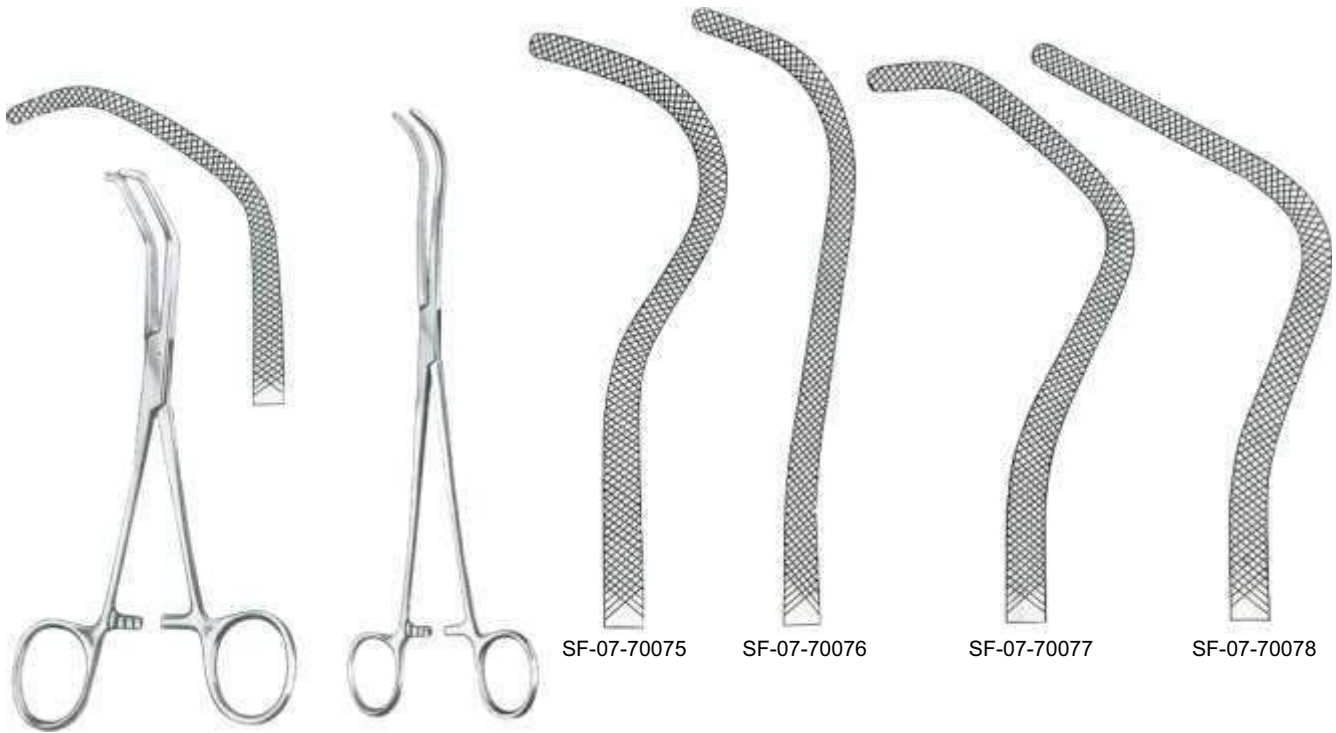

Baby-Satinsky
 SF-07-70074
 15 cm/6"

Harken
 24 cm/9½"

SF-07-70075

SF-07-70076

SF-07-70077

SF-07-70078

AtraumaTC

Atrauma tissue forceps



De Bakey

Wide

SF-07-70079	15.0 cm/6"	1.5 mm
SF-07-70080	19.5 cm/7 ½"	1.5 mm
SF-07-70081	24.0 cm/9 ½"	1.5 mm



De Bakey

	1.2 mm	2.0 mm	Wide
SF-07-70082		69-526-18	18 cm/7"
SF-07-70083		69-526-21	21 cm/8¼"

Atrauma



Cooley

SF-07-70084	15.0 cm/6"
SF-07-70085	19.5 cm/7½"
SF-07-70086	24.0 cm/9½"



De Bakey

Wide	1.5 mm	2.0 mm	2.7 mm	3.5 mm
16 cm/6¼"	SF-07-70087	SF-07-70091	SF-07-70095	SF-07-70099
20 cm/8"	SF-07-70088	SF-07-70092	SF-07-70096	SF-07-70100
24 cm/9½"	SF-07-70089	SF-07-70093	SF-07-70097	SF-07-70101
30 cm/12"	SF-07-70090	SF-07-70094	SF-07-70098	SF-07-70102



De Bakey

Wide 2.0 mm
SF-07-70103
SF-07-70104
SF-07-70105
SF-07-70106



De Bakey

Setting forceps



SF-07-70107
 23 cm/9"



SF-07-70108 7.5 cm/3"
 SF-07-70109 8.5 cm/3½"
 SF-07-70110 10.5 cm/4 ¼"
 SF-07-70111 12.0 cm/4 ¾"



SF-07-70112
 SF-07-70113
 SF-07-70114
 SF-07-70115



SF-07-70116
 3.5 cm/1½"



SF-07-70117
 3.5 cm/1½"



SF-07-70118
 4.5 cm/1¾"



SF-07-70119
 4.5 cm/1¾"



De-Bakey
 SF-07-70120
 5.0 cm/2"



De-Bakey
 SF-07-70121
 5.0 cm/2"



De Bakey



Glover

SF-07-70122	6 cm/2½"
SF-07-70123	7 cm/2¾"
SF-07-70124	9 cm/3½"
SF-07-70125	11 cm/4½"

Glover

SF-07-70126	
SF-07-70127	
SF-07-70128	
SF-07-70129	



Glover
 SF-07-70130
 5 cm/2"



De Bakey-Satinsky
 SF-07-70131
 7 cm/2¾"



De Bakey



De Bakey-Carotid
 SF-07-70132
 9 cm/3½"



De Bakey-Satinsky
 SF-07-70133
 10 cm/4"

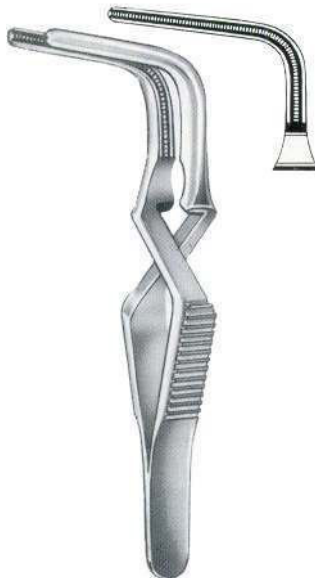

Santulli
 SF-07-70134
 7 cm/2¾"



Gregory-Soft
 SF-07-70135 SF-07-70136
 9 cm/3½" 11 cm/4½"



De Bakey

Coarctation Clamps



**Potts
(De Bakey)**



SF-07-70137
 21 cm/8¼"



SF-07-70138
 22 cm/8¾"



**Potts
(De Bakey)**



SF-07-70139
 21 cm/8¼"



SF-07-70140
 22 cm/8¾"



Potts



SF-07-70141
 21 cm/8¼"



SF-07-70142
 22 cm/8¾"

Anastomosis Clamps



**Glover
(Potts)**



De Bakey



SF-07-70144
21 cm/8¼"

SF-07-70145
22 cm/8¼"

Dissecting and
Ligature Forceps



De Bakey



SF-07-70146
20 cm/8"



SF-07-70147
24 cm/9½"



De Bakey



SF-07-70148
20 cm/8"



SF-07-70149
18 cm/7½"



De Bakey



Leland-Jones



SF-07-70150
 19.5 cm/7½"



SF-07-70151
 19.5 cm/7½"

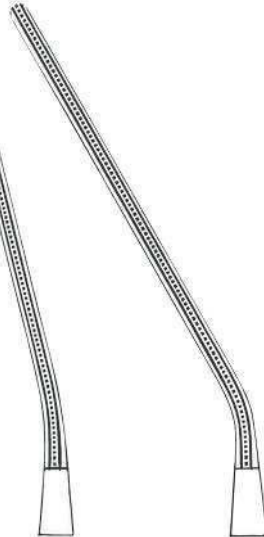

SF-07-70152
 19.5 cm/7½"



Leland-Jones
 SF-07-70153
 18 cm/7"



De Bakey-Bainbirdge



SF-07-70154
 15 cm/6"



SF-07-70155
 18 cm/7"



SF-07-70156
 15 cm/6"



SF-07-70157
 18 cm/7"



De Bakey
 SF-07-70158
 20 cm/8"



De Bakey

Aortic Aneurysm Clamps



De Bakey
SF-07-70159
28 cm/11"



SF-07-70160
30 cm/12"



De Bakey

Aortic Clamps

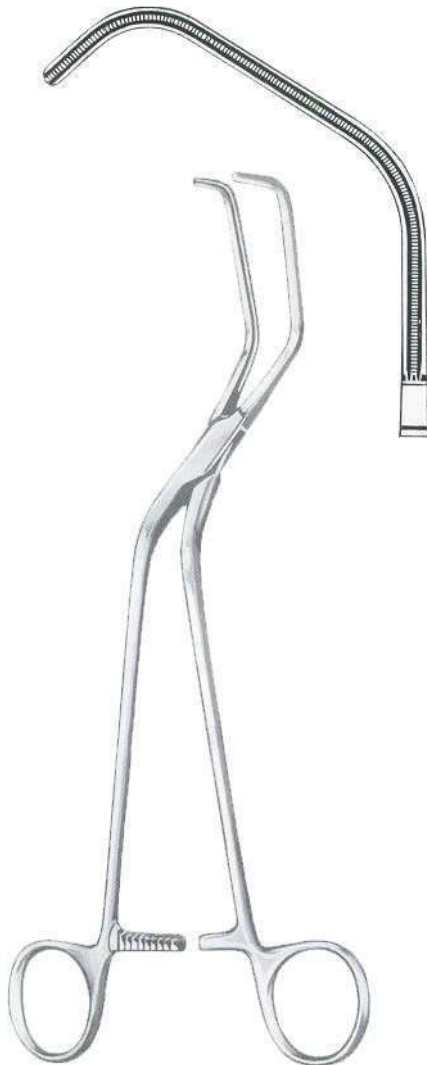

Ochsner
SF-07-70161
23.5 cm/9¼"

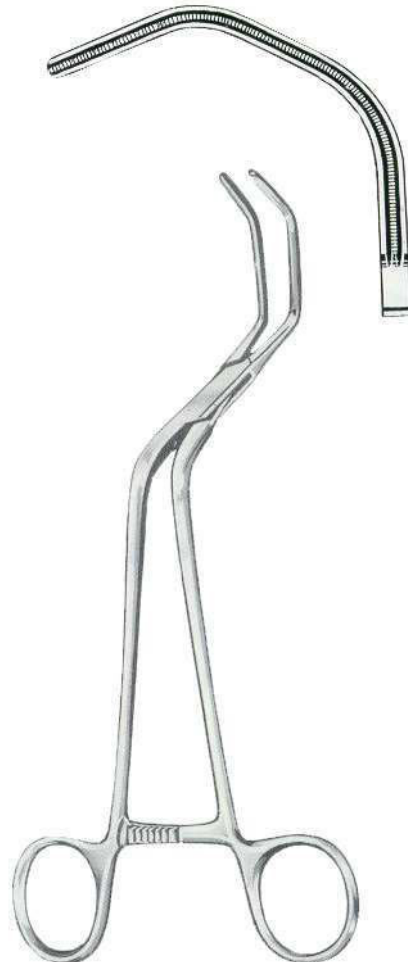

Dietrich
SF-07-70162
21 cm/8¼"



De Bakey



SF-07-70163
24 cm/9½"



SF-07-70164
24 cm/9½"

Auricle Clamp



Harken



SF-07-70165
24 cm/9½"



SF-07-70166
24 cm/9½"



De Bakey

Bronchus Clamps

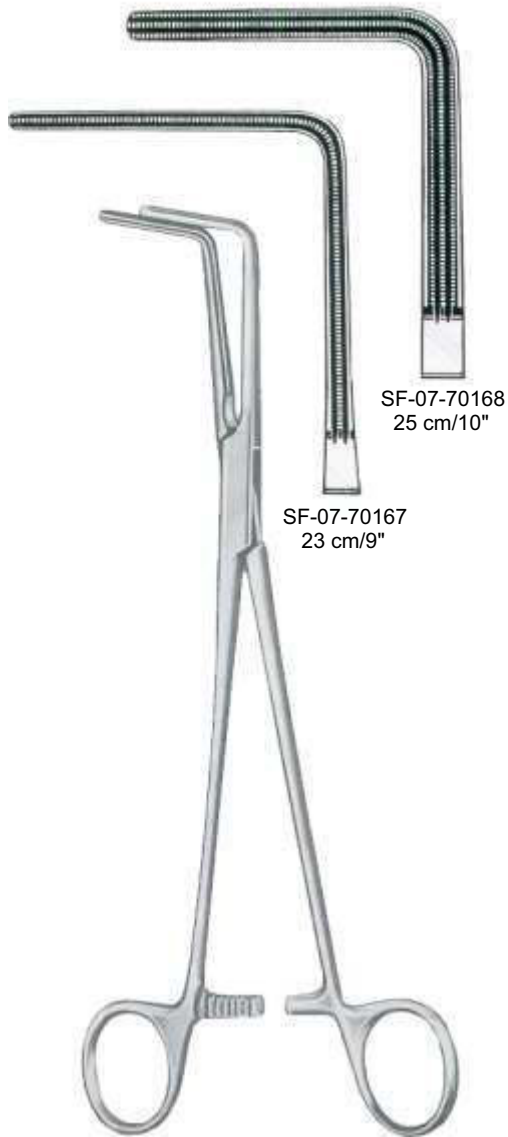

Lees



Lees
SF-07-70169
25 cm/10"



De Bakey

Aortic Clamp

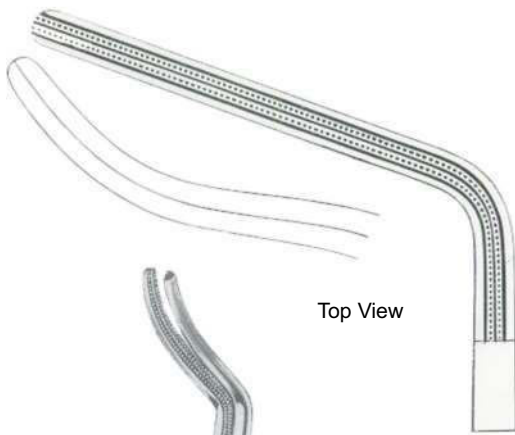

Top View



De Bakey
SF-07-70170
27 cm/10½"



De Bakey
SF-07-70171
24 cm/9½"

Ligature Clamps



De Bakey
SF-07-70172
24 cm/9½"



De Bakey



SF-07-70176



SF-07-70175

Ligature clamp,
Aortic clamp



De Bakey
SF-07-70174
26.5 cm/10½"

De Bakey-Semb
SF-07-70173
25 cm/10"



De Bakey-Semb

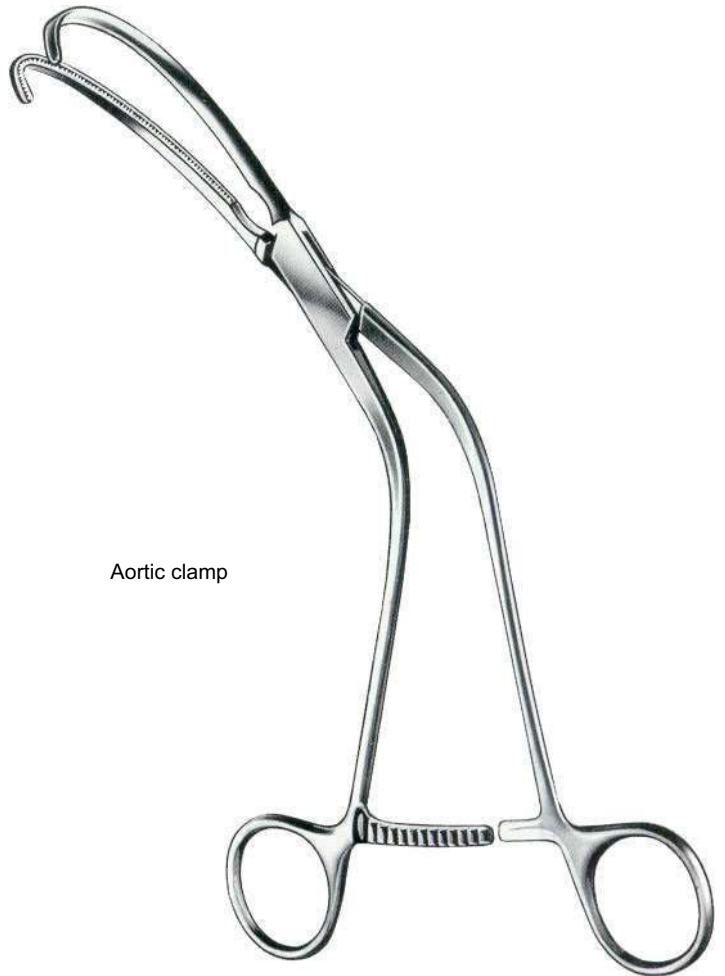

Aortic clamp

Weber
26 cm/10¼"

Cardiovascular Instruments

Atrauma Tangential Occlusion Clamps and Anastomosis Clamps



Satinsky/De Bakey

Tangential occlusion clamps



De Bakey



Set of 5 purchase.
SF-07-70177

SF-07-70178
20 cm/8"

SF-07-70179
25 cm/10"

SF-07-70180
26 cm/10¼"

SF-07-70181
27 cm/10½"

SF-07-70182
28 cm/11"



Glover

SF-07-70183 19.5 cm/7¾"
SF-07-70184 21.0 cm/8¼"

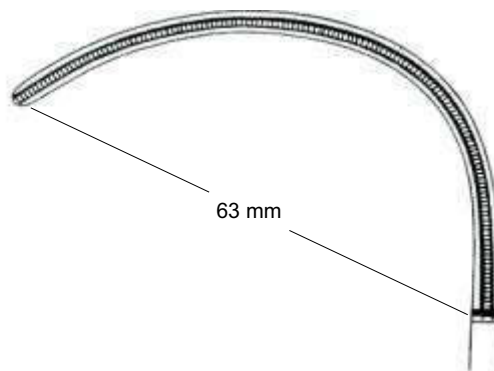

63 mm

Anastomosis

SF-07-70185

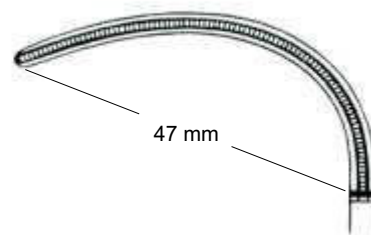

47 mm

SF-07-70186



De Bakey



Lambert-Kay
21 cm/8¼"



Aortic anastomosis clamps

SF-07-70188



De Bakey
SF-07-70189
17 cm/6¾"



Beck
SF-07-70190
17 cm/6¾"

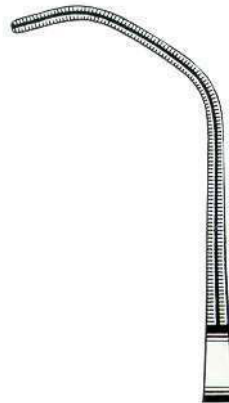



De Bakey



De Bakey
SF-07-70191
16 cm/6 1/4"

Graduated

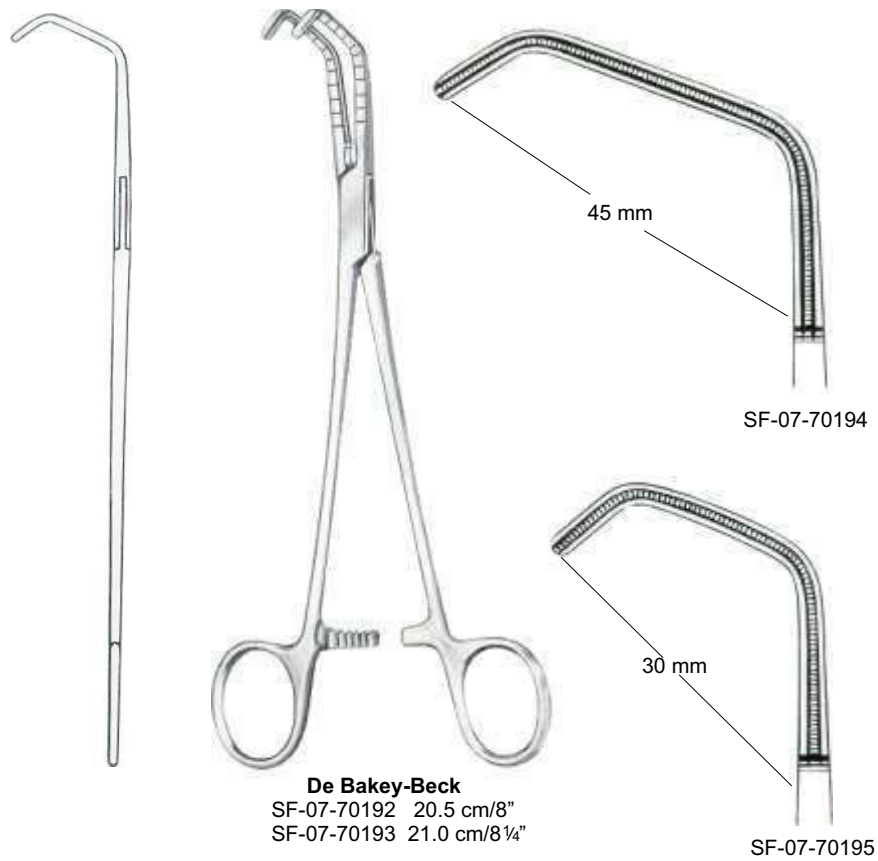

De Bakey-Beck
SF-07-70192 20.5 cm/8"
SF-07-70193 21.0 cm/8 1/4"

SF-07-70194

SF-07-70195

Cardiovascular Instruments

Atrauma Cardiovascular Forceps



69-714-00



15°
69-715-15



30°
69-715-30



45°
69-715-45

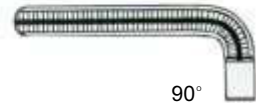

90°
69-715-90



SF-07-70196



15°
SF-07-70197



30°
SF-07-70198



45°
SF-07-70199



90°
SF-07-70200



Dardik
17 cm/6¾"



De Bakey



Multi purpose clamps



De Bakey





Aortic anastomosis clamps

Morris-De Bakey



SF-07-70209
18 cm/7"

SF-07-70210
20 cm/8"

SF-07-70211
23 cm/9"

SF-07-70212
25 cm/10"



Glover
SF-07-70213
24.5 cm/9¾"

Aorta aneurysm clamps



De Bakey-Bahnson



De Bakey



SF-07-70214
 24.5 cm/9¾"



SF-07-70215
 25.5 cm/10"



SF-07-70216
 26.5 cm/10½"

Coarctation clamps



	Straight	cm/in	Curved
SF-07-70217		21.5 cm/8½"	SF-07-70221
SF-07-70218		23.0 cm/9"	SF-07-70222
SF-07-70219		27.0 cm/10½"	SF-07-70223
SF-07-70220		31.5 cm/12½"	SF-07-70224



De Bakey



Mosquito
 12 cm/4¾"

SF-07-70225

SF-07-70226

Atrauma hemostatic forceps



De Bakey-Pean



SF-07-70227
 14 cm/5½"



SF-07-70228
 16 cm/6¼"



SF-07-70229
 18 cm/7"



SF-07-70230
 20 cm/8"



SF-07-70231
 14 cm/5½"



SF-07-70232
 16 cm/6¼"



SF-07-70233
 18 cm/7"



SF-07-70234
 20 cm/8"

Multi purpose clamps



De Bakey



De Bakey-Rankin



SF-07-70235 16 cm/6¼"
 SF-07-70236 16 cm/6¼"



Cooley



SF-07-70236
 16 cm/6¼"



SF-07-70237
 15.5 cm/6"



SF-07-70238
 14.5 cm/5¾"



De Bakey
 SF-07-70239
 17 cm/6¾"



SF-07-70240



SF-07-70241



SF-07-70242



De Bakey

Ligature Clamps

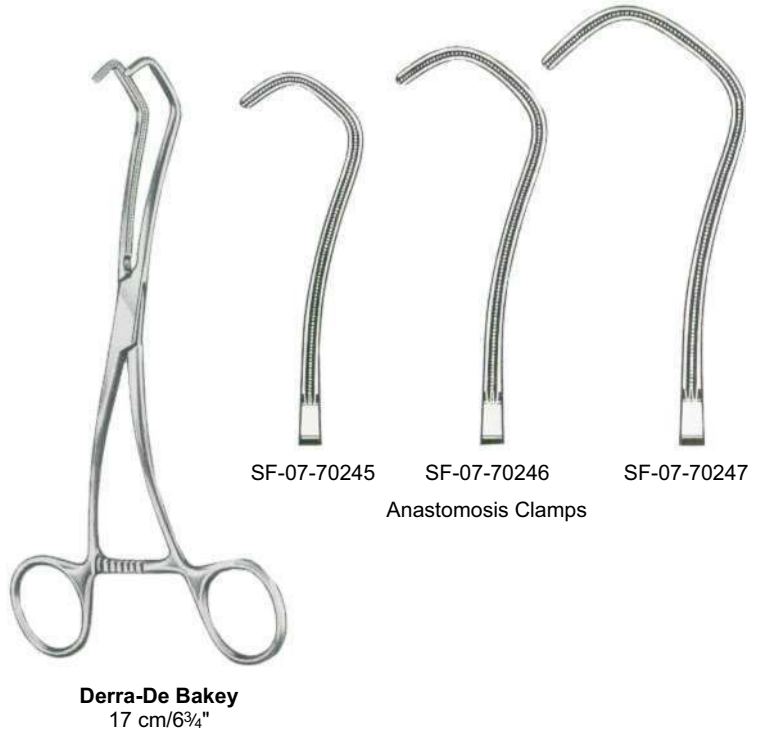
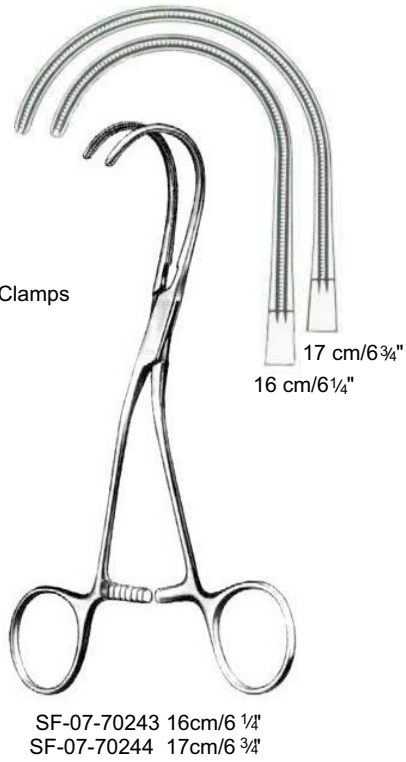

Profunda Clamps

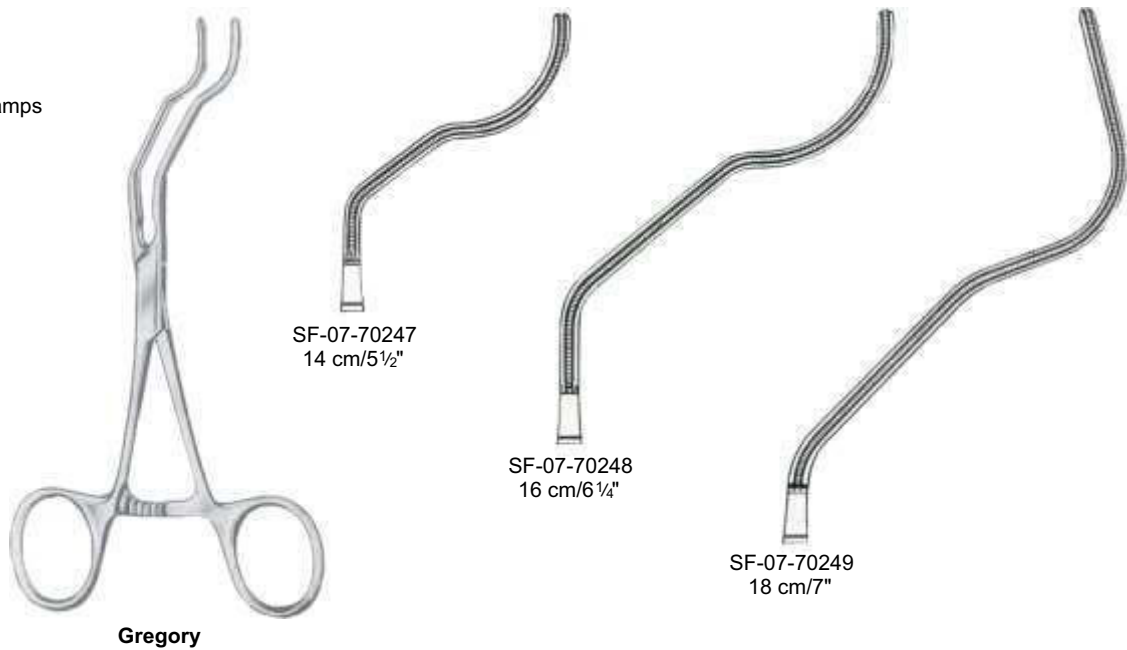

Carotid Clamps



Javid
SF-07-70250
18 cm/7"



Javid
SF-07-70251
19 cm/7½"



Cooley

Charriere (French)	Length cm	
24	16	SF-07-70252
26	16	SF-07-70253
28	20	SF-07-70254
30	20	SF-07-70255
32	20	SF-07-70256
36	20	SF-07-70257



Cooley

Coarctation Clamps



Cooley
SF-07-70258
17 cm/6¾"



SF-07-70259
17 cm/6¾"



SF-07-70260
17 cm/6¾"

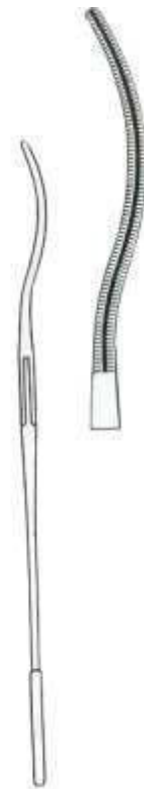

SF-07-70261
17 cm/6¾"



Cooley



Cooley
SF-07-70262
20 cm/8"



Cooley

SF-07-70263
17 cm/6³/₄"



SF-07-70264
15.5 cm/6"



SF-07-70265
15 cm/6"



Cooley
SF-07-70267
17 cm/6³/₄"

Anastomosis clamps



Cooley



Cooley



SF-07-70268
 16.5 cm/6½"

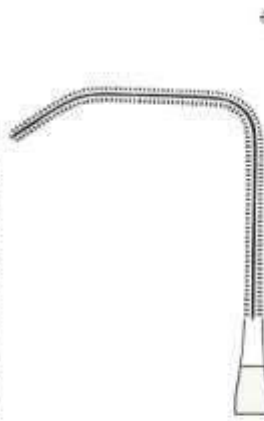

SF-07-70269
 16.5 cm/6½"

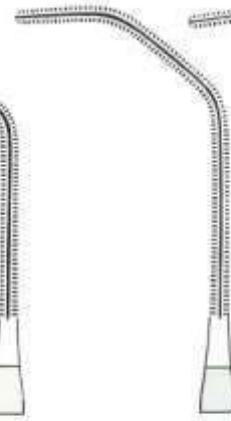

SF-07-70270
 17.5 cm/7"



SF-07-70271
 17.5 cm/7"



Cooley
 SF-07-70272
 16 cm/6¼"



Beck
 SF-07-70273
 17 cm/6¾"



Cooley



Cooley-Derra



SF-07-70274
 16 cm/6 1/4"



SF-07-70275
 17 cm/6 3/4"



SF-07-70276
 18 cm/7"



Cooley
 SF-07-70276 16 cm/6 1/4"
 SF-07-70277 17 cm/6 3/4"



16 cm/6 1/4"

17 cm/6 3/4"

Ligature clamps





Fig.

1

2

3

4

5



Fig.

6

7

8

9

Fig.	Straight
1	SF-07-70283
2	SF-07-70284
3	SF-07-70285
4	SF-07-70286
5	SF-07-70287
6	SF-07-70288
7	SF-07-70289
8	SF-07-70290
9	SF-07-70291

Fig.	Angled
1	SF-07-70292
2	SF-07-70293
3	SF-07-70294
4	SF-07-70295
5	SF-07-70296
6	SF-07-70297
7	SF-07-70298
8	SF-07-70299
9	SF-07-70300

Fig.	Curved
1	SF-07-70301
2	SF-07-70302
3	SF-07-70303
4	SF-07-70304
5	SF-07-70305
6	SF-07-70306
7	SF-07-70307
8	SF-07-70308
9	SF-07-70309





SF-07-70310
13 cm/5"



SF-07-70311
13 cm/5"



SF-07-70312
13 cm/5"



Castaneda



SF-07-70313
15 cm/6"



SF-07-70314
15 cm/6"



SF-07-70315
15 cm/6"



SF-07-70316
15 cm/6"



Cooley
SF-07-70317
25 cm/10"



Cooley
SF-07-70318
33 cm/13"



Cooley
SF-07-70319
30 cm/12"



Cooley
SF-07-70320
30 cm/12"



Cooley
SF-07-70321
35 cm/13¾"

Tourniquets



Rumel-Belmont
SF-07-70322 3.2 mm Ø
SF-07-70323 6.4 mm Ø



Cooley
SF-07-70324



Gerbode
SF-07-70325



Tubbs
SF-07-70326



De Bakey

mm Ø	19 cm/7 1/2"	35 cm/14"
0.5	SF-07-70327	SF-07-70339
1.0	SF-07-70328	SF-07-70340
1.5	SF-07-70329	SF-07-70341
2.0	SF-07-70330	SF-07-70342
2.5	SF-07-70331	SF-07-70343
3.0	SF-07-70332	SF-07-70344
3.5	SF-07-70333	SF-07-70345
4.0	SF-07-70334	SF-07-70346
4.5	SF-07-70335	SF-07-70347
5.0	SF-07-70336	SF-07-70348
7.0	SF-07-70337	SF-07-70349
9.0	SF-07-70338	SF-07-70350

Malleable

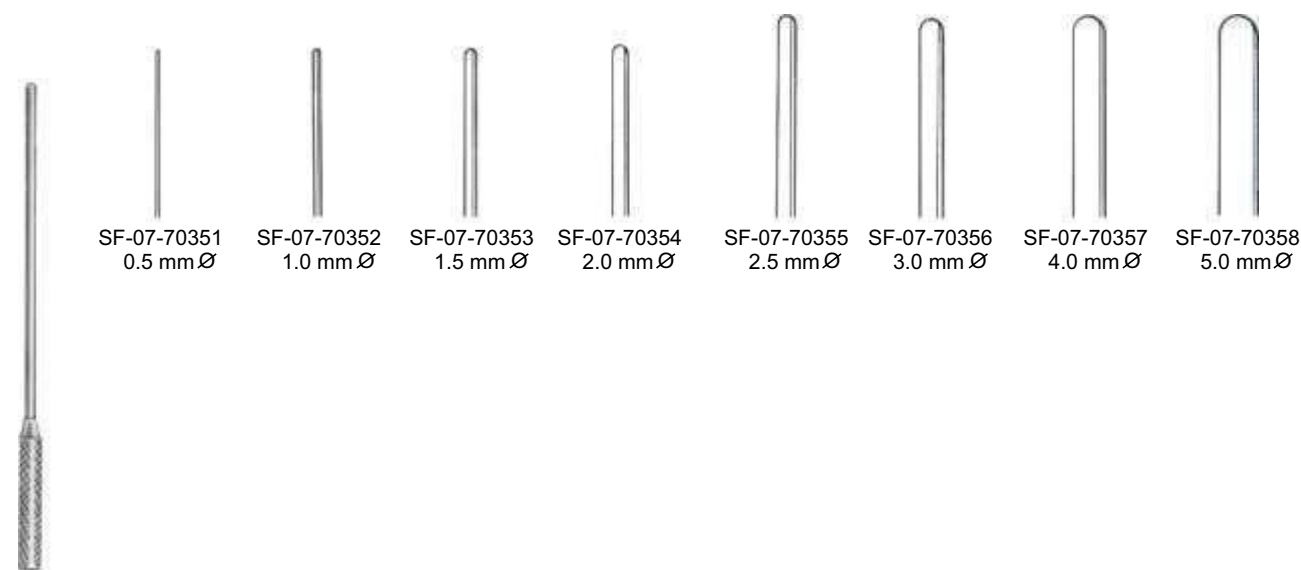

Cooley
 13 cm/5"

SF-07-70351
 0.5 mm Ø

SF-07-70352
 1.0 mm Ø

SF-07-70353
 1.5 mm Ø

SF-07-70354
 2.0 mm Ø

SF-07-70355
 2.5 mm Ø

SF-07-70356
 3.0 mm Ø

SF-07-70357
 4.0 mm Ø

SF-07-70358
 5.0 mm Ø

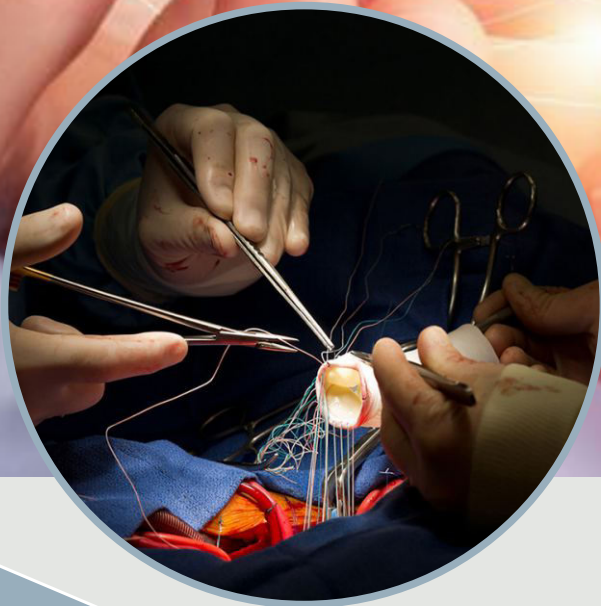

 **SURGIFACT**[®]
EXCELLENCE IS OUR SPECIALTY

+91 98155 11065, +91 98154 11065

vaishanavsurgical@gmail.com

1382/1046, Raja Garden Basti Danishmandan,
Near Vishal Tools, Jalandhar-144002 (Punjab) - India